

Assembly Instruction

MY-SLC-01



Name and Quantity of Parts:



左门

Left Door



右门

Right Door



顶板

1

Top Plate
(1 pcs)



底板

1

Bottom Plate
(1 pcs)



隔板

4

Shelf
(4 pcs)



左侧

1

Left Side
(1 pcs)



右侧

1

Right Side
(1 pcs)



前框

1

Front Frame
(1 pcs)



后背

1

Back Frame
(1 pcs)

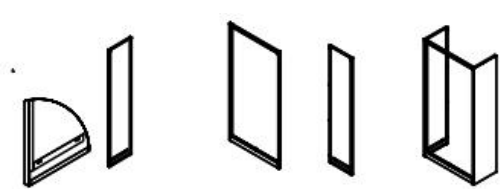

Step1: Take the front frame and place it on the left and right sides



Step2: Install the back frame and connect it to the side panel with screws



Step3: Install the top plate to connect the front and back frame



Step4: Install the bottom plate to connect the front and back frame

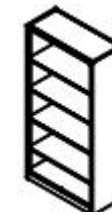

Step5: Install shelf

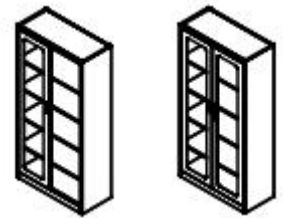









Step6: Install the left and right doors

Assembly Instruction

MY-SLC-02

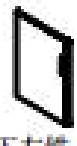
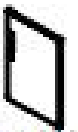

Name and Quantity of Parts:

| | | | | | | | | | | |
|---|---|--|---|---|---|---|---|---|---|---|
|  |  |  |  |  |  |  |  |  |  |  |
| 頂板 1 | 底板 腰板各 1 | 隔板 3 | 左側 1 | 右側 1 | 前框 1 | 后背 1 | 上左玻璃門1 | 上右玻璃門1 | 下左鐵門1 | 下右鐵門1 |
| Top Plate (1 pcs) | Bottom and Middle Plate (1 pcs each) | Shelf (3 pcs) | Left Side (1 pcs) | Right Side (1 pcs) | Front Frame (1 pcs) | Back Frame (1 pcs) | Top Left Glass Door (1 pcs) | Top Right Glass Door (1 pcs) | Lower Left Door (1 pcs) | Lower Right Door (1 pcs) |

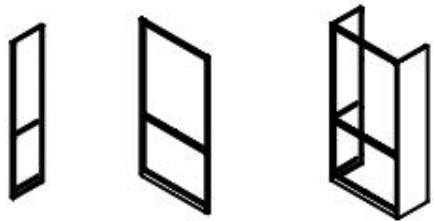

Step1: Take the front frame and place it on the left and right sides

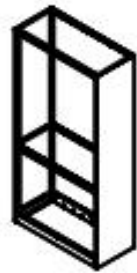

Step2: Install the back frame and connect it to the side panel with screws

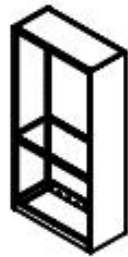

Step3: Install the top plate to connect the front and back frame

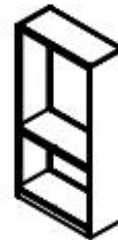

Step4: Install the bottom and middle plate to connect the front and back frame

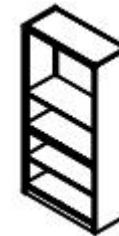

Step5: Install shelf

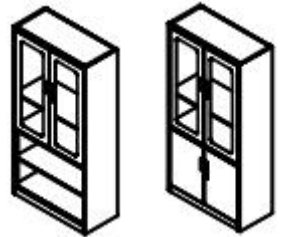

Step6: Install the top, lower, left and right doors

Assembly Instruction

MY-SLC-04



Name and Quantity of Parts:



左门
1

Left Door
(1 pcs)



右门
1

Right Door
(1 pcs)



顶板
1

Top Plate
(1 pcs)



底板
1

Bottom Plate
(1 pcs)



隔板
4

Shelf
(4 pcs)



左侧
1

Left Side
(1 pcs)



右侧
1

Right Side
(1 pcs)



前框
1

Front Frame
(1 pcs)



后背
1

Back Frame
(1 pcs)

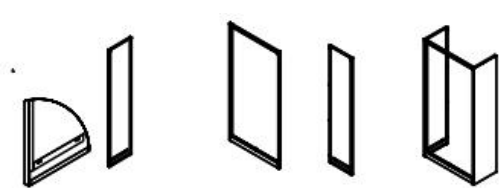

Step1: Take the front frame and place it on the left and right sides



Step2: Install the back frame and connect it to the side panel with screws



Step3: Install the top plate to connect the front and back frame

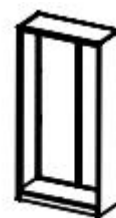

Step4: Install the bottom plate to connect the front and back frame



Step5: Install shelf



Step6: Install the left and right doors

Assembly Instruction

MY-SLC-05



Name and Quantity of Parts:

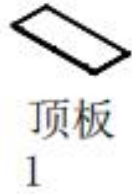

顶板
1

Top Plate
(1 pcs)



底板
腰板各 1

Bottom and
Middle Plate
(1 pcs each)



隔板 2

Shelf
(2 pcs)



左铁门 2

Left Door
(2 pcs)



右铁门 2

Right Door
(2 pcs)



左侧板 1

Left Side
(1 pcs)



右侧板 1

Right Side
(1 pcs)



前框 1

Front Frame
(1 pcs)

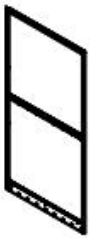

后背 1

Back Frame
(1 pcs)

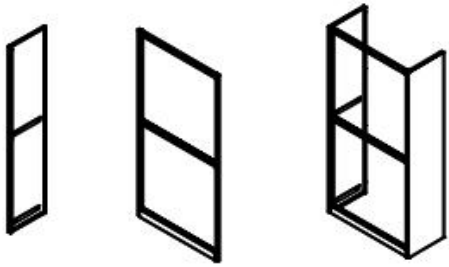

Step1: Take the front frame and place it on the left and right sides

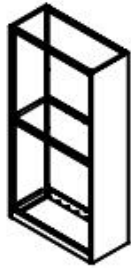

Step2: Install the back frame and connect it to the side panel with screws

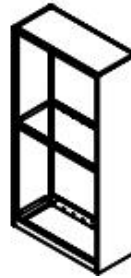

Step3: Install the top plate to connect the front and back frame

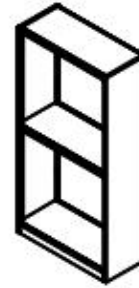

Step4: Install the bottom and middle plate to connect the front and back frame

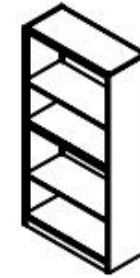

Step5: Install shelf

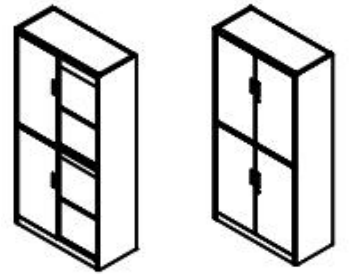

Step6: Install the left and right doors

Assembly Instruction

MY-SLC-13

Name and Quantity of Parts:



上节左右侧



Upper Left and Right Side

上节后背*1



Upper Back Frame (1 pcs)

上节上顶*1



Upper Plate (1 pcs)

上节隔板*3



Upper Shelf (3 pcs)

下节前框



Lower Front Frame

下节左右侧

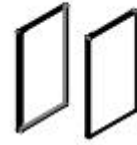

Lower Left and Right Side (1 pcs each)

下节后背



Lower Back Frame

下节下底

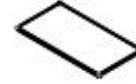

Lower Bottom Plate

下节隔板

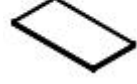

Lower Shelf

下节上顶

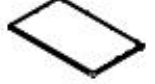

Lower Top Plate

1:取出门框



Step1: Take the lower front frame

2:安装侧板与门框

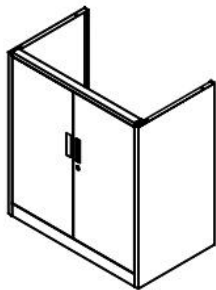

Step2: Install lower left and right side and front frame

3:安装后背

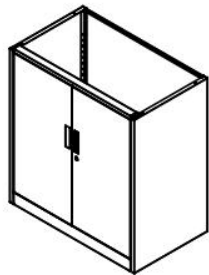

Step3: Install lower back frame

4:安装下底和隔板

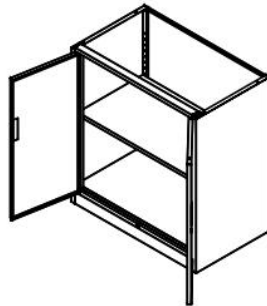

Step4: Install the lower bottom plate and shelf

5:下节顶与上节侧链接

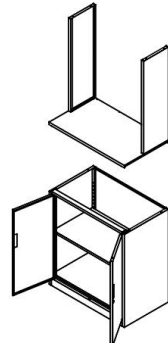

Step5: Combination lower top plate with upper left and right side

6:下节顶与上节侧后背链接

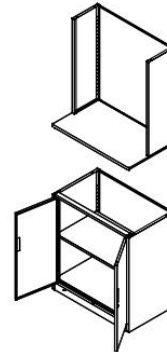

Step6: Install the right and left doors

7:下节顶安装

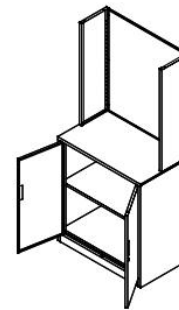

Step7: Install lower top plate

8:上节顶安装

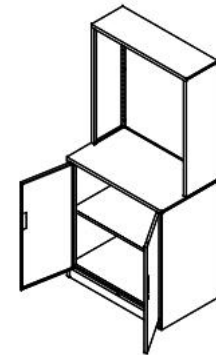

Step8: Install upper top plate

9:上节隔板安装

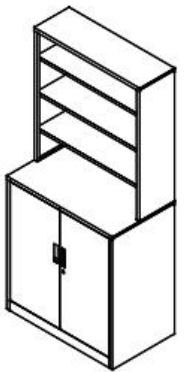

Step9: Install upper shelf

Assembly Instruction

MY-SLC-14



Name and Quantity of Parts:

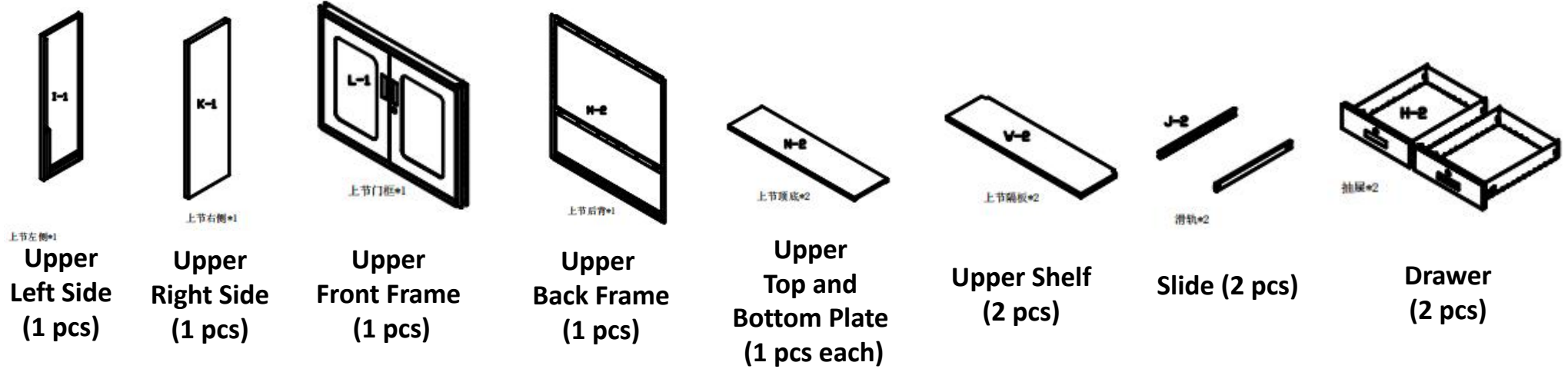

Name and Quantity of Parts:

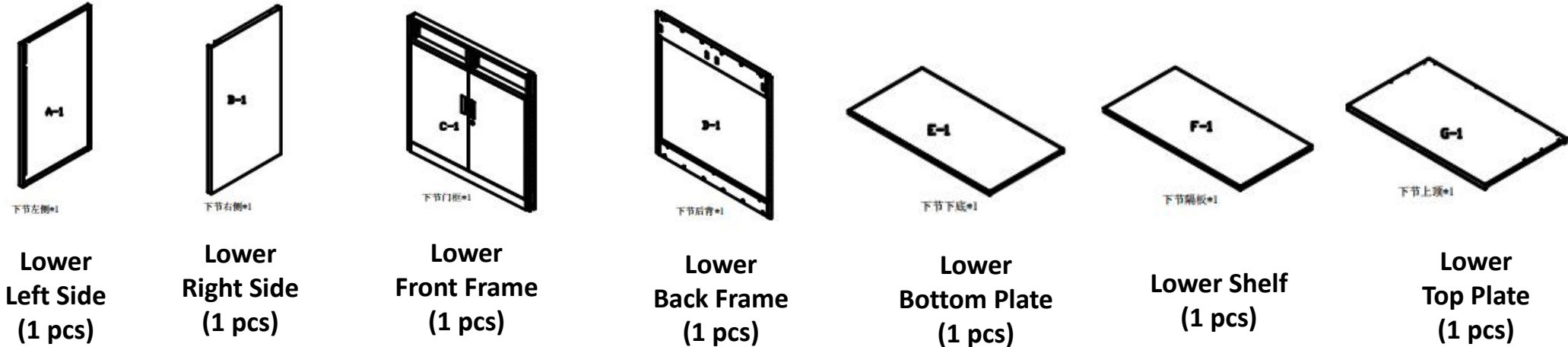

Assembly Instruction

MY-SLC-14



1 取出门框



Step1: Take the lower front frame

2 安装下节左侧



Step2: Install the lower left side

3 安装下节右侧

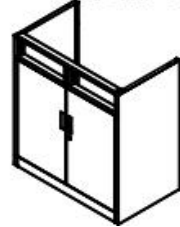

Step3: Install the lower right side

4 安装下节后背



Step4: Install the lower back frame

5 安装下底

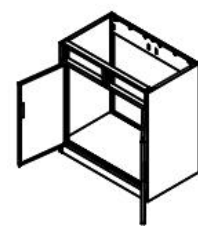

Step5: Install lower bottom plate

6 安装隔板



Step6: Install lower shelf

7 安装抽屉

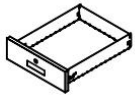

Step7: assembly drawer

9 上节侧板与下节顶组合

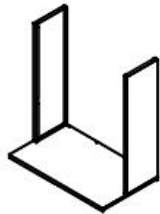

Step9: Combination the upper left and right side with lower top plate

10 下节顶与上节侧后背组合

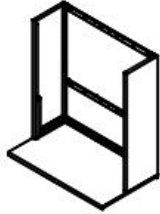

Step10: Combination the upper back frame with lower top plate

11 下节顶部组装



Step11: Install the lower top plate

12 上节门框组装

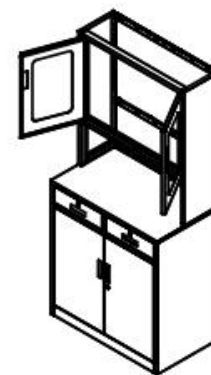

Step12: Install upper front frame

13 上节顶底组装

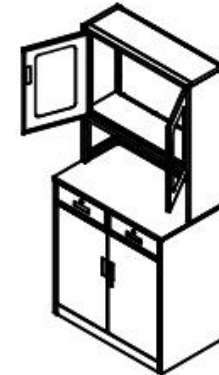

Step13: Install upper top and bottom plate

14 上节隔板组装

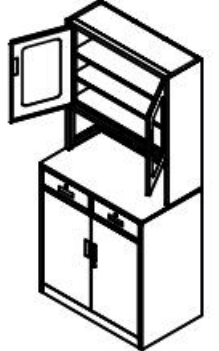

Step14: Install upper shelf

8 安装抽屉

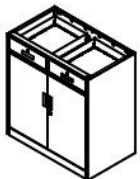

Step8: Install drawer