



## Gas LAVA ROCK GRILL

### Installation and Operation Instructions

Model: 6G-TRH40, 6G-TRH60

Gas catering equipment (Type A) EN 203-1:2014 / BSEN 203-2-10:2007

#### **IMPORTANT FOR FUTURE REFERENCE**

Please complete this information and retain this manual for the life of the equipment. For Warranty Service and/or parts, this information is required.

These instructions are only valid if the country code appears on the appliance. If the code does not appear on the appliance, refer to the technical instructions for adapting the appliance to the conditions for use in that country".

**WARNING:** For your safety, do not store or use gasoline or other flammable vapors or liquids in the vicinity of this or any other appliances. Keep the area free and clear of combustible.



**WARNING :** Improper installation, adjustment, alteration, service or maintenance can cause property damage, injury, or death. Read the installation operating and maintenance instructions thoroughly before installing, or servicing this equipment.



**WARNING:** Instructions must be posted in a prominent location. All safety precautions must be taken in the event the user smells gas. Safety information can be obtained from your local gas supplier.



# Contents

---

<b>Introduction .....</b>	<b>1</b>
<b>Safety Notices and Precautions .....</b>	<b>2</b>
<b>Specifications .....</b>	<b>4</b>
General	
Pack Contents	
Product specification list	
Pressure point	
Gas connection	
Feet adjusting height	
Gas categories and pressure values	
<b>Dimensions.....</b>	<b>6</b>
<b>Installation.....</b>	<b>7</b>
Installation Requirements	
Unpacking	
Location	
Clearances	
Assembly	
Gas Connection	
LP Gas cylinder and compartment	
Commissioning	
<b>Operation.....</b>	<b>12</b>
Operation Guide	
Lighting Main Burners	
Turning OFF Main Burners	
Main burner air supply	
CAUTION	
<b>Cleaning and Maintenance.....</b>	<b>15</b>
General	
After Each Use	
Daily Cleaning	
Periodic Maintenance	
<b>Trouble Shooting .....</b>	<b>17</b>

---

## Introduction

---

Dear customers and users:

We are confident that you will be delighted with your Gas LAVA ROCK GRILL, and it will become a most valued appliance for you.

To ensure you receive the utmost benefit from your new Gas LAVA ROCK GRILL, there are two important things you can do.

### **Firstly:**

Please read the instruction book carefully and follow the directions given. The time taken will be well spent. This instruction manual is subject to any change without further notice, and the manufacturer reserves the right of final interpretation.

### **Secondly:**

If you are unsure of any aspect of the installation, instructions or performance of your appliance, contact your dealer promptly.

### **WARNING:**

INSTRUCTIONS TO BE FOLLOWED IN THE EVENT THE USER SMELLS GAS ARE TO BE POSTED IN A PROMINENT LOCATION. THIS INFORMATION SHALL BE OBTAINED BY CONSULTING THE LOCAL GAS SUPPLIER.

### **WARNING:**

GREAT CARE MUST BE TAKEN BY THE OPERATOR TO USE THE EQUIPMENT SAFELY TO GUARD IT AGAINST RISK OF FIRE.

- THE APPLIANCE MUST NOT BE LEFT ON UNATTENDED.
- IT IS RECOMMENDED THAT A REGULAR INSPECTION IS MADE BY A COMPETENT SERVICE PERSON TO ENSURE CORRECT AND SAFE OPERATION OF YOUR APPLIANCE IS MAINTAINED.
- DO NOT STORE OR USE GASOLINE OR OTHER FLAMMABLE VAPOURS OR LIQUIDS IN THE VICINITY OF THE APPLIANCE.
- DO NOT SPRAY AEROSOLS IN THE VICINITY OF THIS APPLIANCE WHILE IT IS IN OPERATION.

### **CAUTION:**

THIS APPLIANCE IS;

- FOR PROFESSIONAL USE AND IS TO BE USED BY QUALIFIED PERSONS ONLY.
- ONLY QUALIFIED SERVICE PERSONS ARE TO CARRY OUT INSTALLATION, SERVICING AND GAS CONVERSION OPERATIONS.
- COMPONENTS HAVING ADJUSTMENTS PROTECTED BY THE MANUFACTURER SHOULD NOT BE ADJUSTED BY THE USER/OPERATOR.
- DO NOT OPERATE THE APPLIANCE WITHOUT THE LEGS SUPPLIED FITTED.

## Safety Notices and Precautions

---

When using this equipment, safety precautions should always be followed, including the following:

- ◆ Please make sure that the operator is an authorized and licensed technician before you allow him/her to install and operate the products. Be sure to strictly follow this instruction guide during installation and using. The manufacturer is not responsible for any danger or accidents caused by improper operation or maintenance.
- ◆ Do not store flammable or explosive objects around the product. Keep all flammable and explosive objects at a safe distance away from the product for normal using.
- ◆ Place the product in a reasonable position. Regarding related matters of gas, customers should execute the requirements of local gas supply sector.
- ◆ If you smell a gas leak, turn off the gas valves immediately and call the gas company.
- ◆ The product should not be operated by those under 18 years of age, or those with physical or mental disorders, or disabilities that lack the necessary knowledge or experience unless with appropriate instructions and sufficient safety.
- ◆ Warning! For your safety, do not place petrol and other flammables nearby. Please keep clean and free of flammables surroundings.
- ◆ Warning! Any erroneous installation, adjustment and refit may cause property.
- ◆ Do not use out of doors.
- ◆ Damage or personal injury and maintenance failure. Read the instructions carefully before installation and using.
- ◆ Warning! Operation instruction must be placed in a conspicuous location. When customers smell gas in the process of using, should take safety precautions immediately. Immediately turn off the main gas valve, extinguish all heat and flames. Safety information can be obtained from your local gas suppliers.
- ◆ DO NOT SPRAY AEROSOLS IN THE VICINITY OF THIS APPLIANCE WHILE IT IS IN OPERATION.
- ◆ The LAVA ROCK GRILLS and outside surfaces may become hot after use, so you must be careful to touch.
- ◆ During operation, do not directly touch burners and cooking grates.
- ◆ Turn off the equipment as repairing, maintaining and cleaning.
- ◆ If the equipment has any problems of equipment damage, gas piping leaks, igniter or valves damage, or lose product accessories, do not operate, and call for the service immediately.
- ◆ The use of attachments not recommended or sold by the manufacturer may cause fire, personal injury or even death.
- ◆ The equipment is used for cook, not available for any other use.
- ◆ The equipment does not contain any user-serviceable parts. Dealers or technicians will repair it.
- ◆ Do not take apart any spare parts without authorization.
- ◆ Never change any other parts without authorization to this equipment, otherwise, may cause hazards, and the manufacturer has the right not to provide warranty service.
- ◆ Steel cutting producers used to manufacture with sharp edges. The manufacturer has dealt with these sharp edges during production, however, we insist the operator take care when in contact with this piece of equipment.

## Safety Notices and Precautions

---

- ◆ Always keep hands, hair and clothing away from heating source.
- ◆ Wait the unit cools down before cleaning. Because the unit is too hot to handle after using.
- ◆ The parts protected by the manufacturer or his agent shall not be adjusted by the installer.

### **Manufacture's Authority and Responsibility**

- ◆ Banning of all or partial transformation to the products without the manufacturer's explicit authorization.
- ◆ Manufacturers refused to undertake responsibility to third parties as the following reasons:
  - Not follow this instruction guidance and warning in using and testing.
  - Not in accordance with the requirements of technical parameters using this product.
  - Incorrectly or irrationally using the product by untrained personnel.
  - Not obey the local law using this product.
  - Be repaired or changed by unauthorized technicians.
  - Use the spare parts or accessories provided by non-manufacturers.
  - Accidents caused by force majeure.
  - Not strictly comply with related guide of instruction by any reason.

# SPECIFICATION

---

## General

The appliance is designed for commercial purposes, not for household use!

The product is a series of gas char broilers in our company production, which is novel designed, reasonable structured, convenient operated, durable used, and convenient maintained. It's equipped with a high efficiency stainless steel tubular burner, combining flame out protection device and electronic pulse ignition, and convenient to ignite the main fire burner. This is hotel, supermarket, western restaurant, noshery and food industry's ideal cooking product equipment.

## Pack Contents

The following is included:

- The Gas LAVA ROCK GRILL
- Four Feet
- Instruction Manual
- The gas lava rock

## Product specification list:

3.

Model	6G-TRH40	6G-TRH60
Dimension (mm)	400×650×540	600×650×540
Height of working table	335	335
Gas inlet size	R1 1/2"	R1 1/2"

Gas	Orifice dia.	Gas pressure.	Total power	
			6G-TRH60	6G-TRH40
G30	1.3mm	29mbar	6kW x2	6kW
G30	1.2mm	37mbar	6kW x2	6kW
G30	1.1mm	50mbar	6kW x2	6kW
G20	2.2mm	20mbar	7.5kW x2	7.5kW
G25.3	2.2mm	25mbar	7.3kW x2	7.3kW

## Pressure point:

The burner operating pressure is to be measured at the manifold test point with one or two burners operating at full setting. The operating pressure is ex-factory set, through the appliance regulator and is not to be adjusted.

## Gas connection:

Gas connection shall be fixed with the matched gas adaptor with seal gasket to suit for various national situation.

**Feet adjusting height:** 100-140mm

# Installation

---

## Installation Requirements

### NOTE:

- **It is most important that this appliance is installed correctly and that operation is correct before use. Installation shall comply with local gas, health and safety requirements.**
- **This appliance shall be installed with sufficient ventilation to prevent the occurrence of unacceptable concentrations of substances harmful to health.**

Our Gas LAVA ROCK GRILLS are designed to provide years of satisfactory service and correct installation is essential to achieve the best performance, efficiency and trouble-free operation.

This appliance must be installed in accordance with National installation codes and in addition, in accordance with relevant National / Local codes covering gas and fire safety.

**Installations must be carried out by qualified persons only. Failure to install equipment to the relevant codes and manufacturer's specifications shown in this section will void the warranty.**

**Components having adjustments protected by the manufacturer are only to be adjusted by an authorized service agent. They are not to be adjusted by the installation person.**

### Unpacking

- Remove all packaging and transit protection from the appliance including all protective plastic coating from the exterior stainless steel panels.
- Check equipment and parts for damage. Report any damage immediately to the carrier and distributor.
- Ensure that the 4 adjustable feet are fitted with the protruding centre screw.
- Report any deficiencies to the distributor who supplied the appliance.
- Check that the available gas supply is correct to that shown on the rating plate located on the right hand panel.

### Location

1. Installation must allow for a sufficient flow of fresh air for the combustion air supply.
2. Installation must include adequate ventilation means, to prevent dangerous build-up of combustion products.
3. Any gas burning appliance requires adequate clearance and ventilation for optimum and trouble-free operation. The minimum installation clearances shown below are to be adhered to.
4. Position the appliance in its approximate working position.
5. All air for burner combustion is supplied from underneath the unit. The legs must always be fitted and no obstructions placed on the underside or around the base of the unit, as obstructions will cause incorrect operation and / or failure of the appliance.
6. Components having adjustments protected by manufacturer are only allowed to be adjusted by an authorized service agent. They are not to be adjusted by the installation person.

## Installation

---

### Clearances

NOTE: Only non-combustible materials can be used in close proximity to this appliance.

	Combustible Surface	Non Combustible Surface
Left / Right Hand Side	Not applicable	150mm Min.
Rear	Not applicable	150mm Min.
Bottom	Not applicable	150mm Min.

### Assembly

#### NOTE:

- ◆ This appliance is assembled before delivery except feet.
- ◆ This appliance is fitted with adjustable feet to enable the appliance to be positioned securely and level.
- ◆ Check all accessories complete.
- ◆ IM will be stated that the appliance shall be installed in such a way that side body surfaces are not accessible in the installed position.

### Gas Connection

#### NOTE: ALL GAS FITTING MUST ONLY BE CARRIED OUT BY A QUALIFIED PERSON.

1. The Gas LAVA ROCK GRILL do not require an electrical connection, as they function totally on the gas supply only.
2. It is essential that the gas supply is correct for the appliance to be installed and that adequate supply pressure and volume are available. The following checks should therefore be made before installation:-
  - a. Gas Type required for the appliance is shown in the rating label. Check that this is correct for the gas supply the appliance is being installed for gas LAVA ROCK GRILL, The gas conversion is not suited for gas LAVA ROCK GRILL.
  - b. Supply Pressure required for this appliance is shown in the 'Gas supply requirements' section of this manual. Check the gas supply to ensure adequate supply pressure exists.
  - c. Input Rate of this appliance is stated on the Rating label .The input rate should be checked against the available gas supply line capacity. Particular note should be taken if the appliance is being added to an existing installation.
  - d. The gas supply tubing or hose shall comply with the national requirements in force and shall be periodically examined and replaced as necessary.
  - e. Only local national requirements rubber or PVC flexible hose(Nominal core of hose shall be 6.3mm to12.5mm) could be used for LP gas connection. The length of flexible hose shall not be more than 1.5meters. The flexible hose shall not come into contact with sharp edges.
  - f. LP Gas Regulator, flexible hose adaptor and rubber gasket shall be matched with local national requirements, A Manual Isolation Valve must be fitted to the individual appliance supply line. The regulator should be certificated according to EN16129 latest version. And the hose should be Certificated according to the latest version EN 16436-1, BSEN ISO3821, BSEN1327 or DIN 1763
  - g. Nature gas shall be connected with from nature gas supply pipe to nature gas regulator and connection adaptor to match with local national installation requirements. The nature gas supply line must be at least the equivalent of ½" (12.7 mm) iron pipe for single units, A Manual Isolation Valve must be fitted to the individual appliance supply line.
  - h. The appliance should be connected to the gas supply by means of Flexible hose or metal pipes --either rigid or flexible-- having an adequate diameter. When joining pipe fittings, never use oakum or Teflon as their residues could get to the valve and jeopardize its operation. Instead, interpose a seal gasket suitable for use in gas systems.



## Installation

---

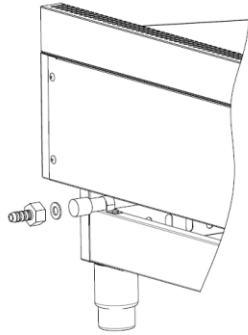

LP Gas hose connection

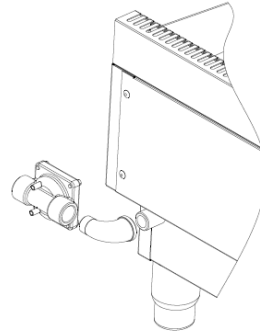

Nature gas connection

**NOTE: Manual Isolation Valve, Gas hose adaptor, seal gasket, gas pipe, LP or nature regulator and flexible hose were not include with current product. Purchase them in your local site. The gas type and gas pressure shall be matched with gas rating label in product body. Any issue pls. contact the Dealer of this appliance.**

**NOTE:** It is important that adequately sized piping runs directly to the connection joint on the appliance with as few tees and elbows as possible to give maximum supply volume

**NOTE:** Ensure the regulator is converted to the correct gas type that the appliance will operate on. The regulator outlet pressure is fixed ex-factory for the gas type .

**NOTE: the appliance should be used on a table , the table material should be Non Combustible and the height should be not exceed 800mm .**

Correctly locate the appliance into its final operating position and using a spirit level, adjust the legs so that the unit is level and at the correct height.

3. Connect the gas supply to the appliance through the regulator. (refer to the picture of "Install the Regulator. A suitable jointing compound which resists the breakdown action of propane must be used on every gas line connection, unless compression fittings are used.
4. Check all gas connections for leakages.

**WARNING:**

DO NOT USE A NAKED FLAME TO CHECK FOR GAS LEAKAGES.

5. Check that the gas operating pressure.

**NOTE:** The operating pressure to be measured at the manifold test point and with 2 burners operating at the 'High Flame' setting.

6. Turn off the mains gas supply and bleed the gas out of the appliance gas lines.
7. Turn on the gas supply and the appliance.
8. Verify that the operating pressure remains correct.
9. All gas supply connections and any pipe joint compound must be resistant to the action of nature gas and propane gases.
10. The gas inlet is located on the lower rear of the LAVA ROCK GRILL . Codes require that a gas shutoff valve be
11. installed in the gas line ahead of the LAVA ROCK GRILL.
12. Make sure the pipes are clean and free of obstructions, dirt, and piping compound.
13. After installing completely, you should check gas supply pressure. Use a pressure gauge which is equipped with liquid (such as U-type pressure gauge, the minimum value is 0.1mbar) or a digital pressure gauge to test. Steps are as following:

## Installation

---

14. Turn over gas LAVA ROCK GRILL , and needle type pressure joint screw arbor (Fig.1), then slip rubber tube of pressure gauge over needle type pressure joint;
15. Start the equipment in accordance with the instructions, measuring gas supply pressure (dynamic pressure) in the work state;
16. Access to the equipment if measured data within the limits of Table 1, otherwise, you will need to adjust gas pressure regulating valve or contact gas supplier to bargain;
17. The gas inlet is located on the lower rear of the LAVA ROCK GRILL . Codes require that a gas shutoff valve be
18. installed in the gas line ahead of the LAVA ROCK GRILL.
19. Make sure the pipes are clean and free of obstructions, dirt, and piping compound.

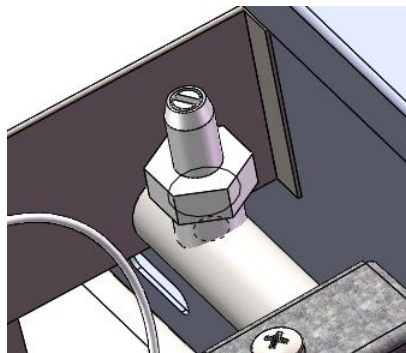

Fig.1

**NOTE:** LP Gas cylinder shall be purchased from local site and matched with local national requirements, Supply gas type and pressure required for this appliance was shown on rating label , 9kg to 23kg LP gas cylinder shall be used for current gas LAVA ROCK GRILL. maximal external dimensions (regulator included) shall not be more than dia. 500mm X900mm.

### LP Gas cylinder

1. LP Gas cylinder shall be Kept with 1meters Min space from gas LAVA ROCK GRILL. gas cylinder shall be located outside the appliance in well ventilation space, Gas cylinder shall never be moved during operation period, it shall be fixed with rigid support.
2. If gas cylinder was inserted with compartment, effective ventilation is provided by openings compartment base and upper side areas. The total area of the openings in the upper part being at least 1/100th of the floor area of the compartment and that of the openings at the base being at least 1/50th of the floor area of the compartment;
3. The cylinder support has sufficient mechanical strength to resist permanent deformation under the load weight of a full cylinder; an arrangement with the cylinder resting directly on the ground is not allowed
4. The cylinder fitted with a regulator can be easily installed or removed from the compartment, the cylinder can be easily installed in a vertical position with the valve and regulator upper most; the cylinder valve is accessible and remain easy to manipulate when the cylinder is in place;
5. no internal communication means or conduits shall exist between the cylinder compartment and parts of the appliance where burners are located, It shall not be possible to block or obstruct the ventilation openings of the compartment accidentally, when the gas cylinder is placed in position.
6. The compartment shall be designed and constructed in such a way as to ensure that a permanent supply of fresh air is ensured and there is no accumulation of un-burnt gases.

# Installation

---

## Commissioning

1. Before leaving the new installation;
  - a. Check the following functions in accordance with the operating instructions specified in the 'Operation' section of this manual.
    - ◆ Turning 'Off' the Main Burner.
    - ◆ Electrical battery installation
    - ◆ Light the Main Burner.
  - b. Ensure that the operator has been instructed in the areas of correct lighting, operation, and shutdown procedure for the appliance.
2. This manual must be kept by the owner for future reference and a record of the Date of Purchase, Date of Installation and the Serial Number of the Appliance must be recorded and kept with this manual. (These details can be found on the Rating label, refer to the 'Gas Connection' section).

**NOTE:** If for some reason it is not possible to get the appliance to operate correctly, shut off the gas supply and contact the supplier of this appliance.

# Operation

## Operation Guide

### **CAUTION:**

- This appliance is for professional use and is only to be used by qualified persons.
- Only authorized service persons are to carry out installation, servicing or gas conversion operation operations.
- Components having adjustments protected by the manufacturer should not be adjusted by the user/operator.

1. The Gas LAVA ROCK GRILL have been designed to provide simplicity of operation and 100% safety protection.
2. Before operating, make sure to place the unit horizontally by adjusting bottom adjustable legs,
3. Improper operation is therefore almost impossible, however bad operation practices can reduce the life of the appliance. To use this appliance correctly please read the following sections carefully:
  - Lighting the Main Burner.
  - Turning off the Main Burner.

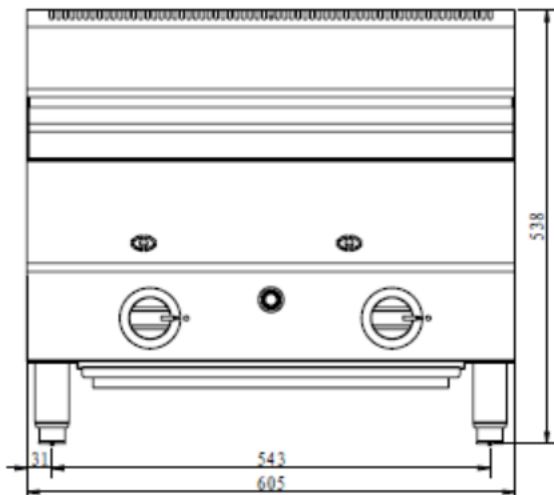
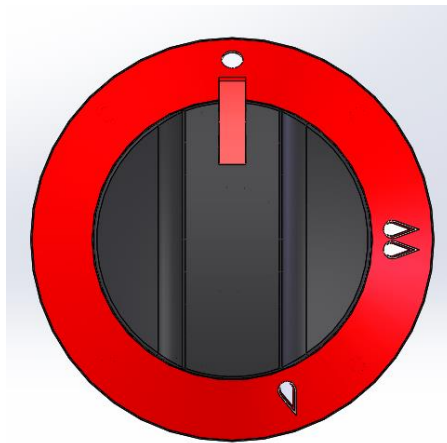



## Operation

---

### Lighting Main Burners

The LAVA ROCK GRILL are fitted with Flame Failure Protection is incorporated for each burner by way of a thermo-electric system which will shut off the gas supply to that burner in the event that the burner goes out, so that un-burnt gas is not expelled.

Before using electronic pulse ignition, open the bottom and put a No.7 battery in it

- Turn the knob to align "●" with salient position. The valve is OFF.
- Hold down the valve knob and at the same time press down igniter.
- Keep pressing the knob about 5-10 seconds, and observe stability of fire. After ignition, release the knob 20s later.
- The burner should stay alight - if not, close the burner, wait for 5 minutes, then repeat above ignition procedure.
- To work in MAX power, turn gas control knob to 'HIGH'  
- To work in MIN power, turn gas control knob to  .
- To achieve simmer control, turn gas control knob between the 'HIGH' and 'LOW' positions to achieve the temperature required.
- To turn "OFF" the appliance completely, turn the gas control knob completely clockwise to the "●" position, the burner will extinguish.

Tip: There is air in the pipeline when the first time light the fire, then can normally light the pilot light until flow out air.

### Turning OFF Main Burners

Rotate the gas control knob to the 'OFF' position. The main burner will extinguish.

### Main burner air supply

1. For efficient burner operation, a proper balance of gas volume and primary air supply must be maintained which will result in complete combustion. Insufficient air supply results in a yellow streaming flame. Primary air supply is controlled by an air shutter on the front of the burner.
2. Loosen the screws on the front of the burner and adjust the air shutter to just eliminate the yellow tips of the burner flame. Lock the air shutter in place by tightening the screws.

### CAUTION

The space between the legs at the bottom admits combustion air. DO NOT BLOCK THIS SPACE.

All burners are lit from constantly burning pilots. Turning the valve to the desired flame height is all that is required to put the unit in service.

Do not permit fans to blow directly at the unit. Wherever possible, avoid open windows next to the units' sides or back. Avoid wall type fans which create air cross-currents within a room.

It is also necessary that sufficient air should be allowed to enter the room to compensate for the amount of air removed by any ventilating system. Otherwise, a subnormal atmospheric pressure will occur, affecting operation and causing undesirable working conditions.

A properly designed and installed hood will act as the heart of the ventilating system for the room or area in which the unit is installed, and will leave the unit independent of changing draft

conditions.

All valves must be checked and lubricated periodically. This must be done by an authorized service representative in your area.

## **Operation**

---

**Note:** Please wait at least 15 seconds to restart the main burners to maintain the best function of the thermostat valve after turning off the main burners.

### **IMPORTANT**

**Should any abnormal operation like;**

- ignition problems,
- abnormal burner flame,
- burner control problems,
- partial or full loss of burner flame in normal operation, be noticed, the appliance requires IMMEDIATE service by a qualified service person and should not be used until such service is carried out.

## Cleaning and Maintenance

---

### **CAUTION:**

Always turn off the gas supply before cleaning.  
This appliance is not water proof.  
Do not use water jet spray to clean this appliance.

### **GENERAL**

Clean the Gas LAVA ROCK GRILL regularly. A clean Gas LAVA ROCK GRILL looks better, will last longer and will perform better. Carbonised grease on the surface or between the trivets, will hinder the transfer of heat from the cooking surface to the food. This will result in loss of cooking efficiency.

DO NOT use water on the trivets, burners while these items are still hot as warping and cracking may occur. Allow these items to cool down and then remove for cleaning.

The entire trivets burner can be dismantled for cleaning.

### **NOTE:**

- DO NOT use abrasive detergents, strong solvents or caustic detergents as they could corrode or damage the Gas LAVA ROCK GRILL.
- In order to prevent the forming of rust on the trivets, and burners, ensure that any detergent or cleaning material has been completely removed after each cleaning.

### **DAILY CLEANING**

1. The drip tray should be checked and emptied frequently to prevent overflow and spillage. Remove the drip tray while still warm so that the grease is in a liquid state. Empty any grease from the trays and wash thoroughly in the same manner as any cooking utensil.
2. Remove the burner, the trivets and thoroughly clean the splash back, interior and exterior surfaces of the range with hot water, a detergent solution and a soft scrubbing brush.
3. Dry the Gas LAVA ROCK GRILL thoroughly with a dry cloth and polish with a soft dry cloth.

### **NOTE:**

- If the LAVA ROCK GRILL usage is very high, we recommend that the weekly cleaning procedure is carried out on a more frequent basis.
- Ensure that protective gloves are worn during the cleaning process.
- DO NOT use harsh abrasive detergents, strong solvents or caustic detergents as they will damage the grate and burners.
- Allow these items castings to cool and remove for cleaning.
- Parts protected by the manufacturer or his agent are not to be adjusted by the installer, unless the installer is an authorized service agent.
- Systematic checking and suitable cleaning of the inside of grill before it is lit in order to avoid the emission of fire from the oils that have accumulated during previous cooking. In the case of the use of a bed of lava stones or any other material generating dust it is necessary to remember that regular cleaning of the burner outlets with a metal brush or any other such utensil recommended by the manufacturer, is necessary to avoid obstruction and to allow a good combustion.
- There is a bag of lava rock (about 2.5kg) in the appliance. Please put them evenly on bottom grate.

### **Periodic Maintenance**

**NOTE: All maintenance operations should only be carried out by a qualified service person.**

To achieve the best results cleaning must be regular and thorough and all controls and mechanical parts should be checked and adjusted periodically by a qualified service person. If any small faults occur, have them attended to promptly. Don't wait until they cause a complete breakdown.

## Maintenance

---

The following maintenance operations should be performed at least once a **Half** year:

Checking for proper operation of all control and safety devices;

Checking burner combustion, i.e.:

1. ignition;
2. combustion safety;
3. checking for proper operation throughout the entire HIGH-to-LOW control range.

We recommend signing a service agreement providing for at least one check-up a **Half** year. Cleaning and

### Burners

- a. Remove the burner from the top of the bracket of appliance
- b. The burners should be cleaned with a mild detergent and hot water solution using a soft bristled brush. Dry thoroughly with a dry cloth.

### Stainless Steel Surfaces

- a. With the trivet and burners removed, clean the interior and exterior surfaces of the Gas LAVA ROCK GRILL with hot water, a mild detergent solution and a soft scrubbing brush. Note that the gas control knobs are a push fit onto the gas control valve spindles and can be removed to allow cleaning of the front of the control panel.
- b. Baked on deposits or discoloration may require a good quality stainless steel cleaner or stainless steel wool. Always apply cleaner when the appliance is cold and rub in the direction of the grain.
- c. Dry all components thoroughly with a dry cloth and polish with a soft dry cloth.
- d. To remove any dis-colouration, use an approved stainless steel cleaner or stainless steel wool. Always rub in the direction of the grain.
- e. Remove the drip tray and clean with a mild anti-bacterial detergent and hot water solution using a soft bristled brush.
- f. Dry the drip tray thoroughly with a dry cloth.



## Trouble Shooting

This section provides an easy reference guide to the more common problems that may occur during the operation of your equipment. The fault finding guide in this section is intended to help you correct, or at least accurately diagnose problems with your equipment.

Although this section covers the most common problems reported, you may encounter a problem not covered in this section. In such instances, please contact your local authorized service agent who will make every effort to help you identify and resolve the problem. Please note that the service agent will require the following information:

- **Model Code and the Serial Number of the appliance. (Both of them can be found on the Rating Plate located on the appliance).**

Fault	Possible Cause	Remedy
Main burner will not light.	Insufficient gas pressure in pipe	Contact the local gas supply dept.
	No gas supply.	Ensure gas isolation valve is turned on, and that bottles are not empty. Call the service provider. .
	Nozzle occlusion	Dredge nozzle
	Thermocouple connection loose	Tighten thermocouple
	Thermocouple damage	Replace thermocouple
	Gas control valve failure	Replace control valve
No spark flame on main burner	Faulty battery for electronic pulse ignition device	Put No 7 battery into ignition device
	Faulty electronic pulse ignition device	Replace electronic pulse ignition device
Yellow flame and black smoke	Use the gas of bottom	Replace gas
	Not match nozzle diameter with gas resources	Adjust nozzle diameter
	Not enough air to ignite	Increase damper opening degree
	In the peak of using gas, sources of gas float heavy	Turn down valves flow. Turn it up after the peak

The problems mentioned above are only for reference. If any fault occurs, please stop using, and contact technicians to check and repair. Safety first, turn off the power and gas supply before maintenance.

**NOTE:** Components having adjustments protected by the manufacturer are only to be adjusted by an authorized service agent. They are not to be adjusted by an unauthorized service person.

---

**IMPORTANT:**

Only genuine authorized replacement parts should be used for the servicing and repair of this appliance. The instructions supplied with the parts should be followed when replacing components.

For further information and servicing instructions, contact your nearest authorized service branch.

When ordering replacement parts, please quote the part number and the description listing below. If the part required is not listed below, request the part by description and quote model number and serial number which is shown on the rating plate.

**CAUTION: Please replace the corresponding warning label that shows the gas type operated when the qualified person will convert to another gas in order not to cause death or injury or damage.**

# ADEXA DIRECT LIMITED

Unit 1 Swift Point, Cosford Lane, Swift Valley Industrial Estate, Rugby, CV21 1QN, UK  
T:+44 1788 222 410    service@adexa.co.uk    www.adexa.co.uk

---



## EC Declaration of Conformity

Adexa Direct Limited declares that:

**Equipment Type:** Gas grill

**Model:** 6G-TRH40, 6G-TRH60

**Imported By:** ADEXA DIRECT LIMITED  
Unit 1 Swift Point, Cosford Lane, Swift Valley Industrial  
Estate, Rugby, CV21 1QN, UK

**Brand:** ADEXA

**Application of Council Directive(s):** (EU) 2016/426 (9 March 2016)

**Standards:** EN 203-1:2021, EN 203-2-10:2007  
EN 203-3:2009

I, the undersigned, hereby declare that the equipment specified above conforms to the above Directive(s) and Standard(s).

Date: 05.05.2023

Signature: 

Full Name: Hakan Baykal

Position: Purchase Manager

# ADEXA DIRECT LIMITED

Unit 1 Swift Point, Cosford Lane, Swift Valley Industrial Estate, Rugby, CV21 1QN, UK  
T:+44 1788 222 410    service@adexa.co.uk    www.adexa.co.uk

---



## Declaration of Conformity

Adexa Direct Limited declares that:

**Equipment Type:** Gas grill

**Model:** 6G-TRH40, 6G-TRH60

**Imported By:** ADEXA DIRECT LIMITED  
Unit 1 Swift Point, Cosford Lane, Swift Valley Industrial Estate, Rugby, CV21 1QN, UK

**Brand:** ADEXA

**Application of Council Directive(s):** (EU) 2016/426  
2018 No 389  
UK SI 2019/696  
2019 No 1246

**Standards:** BS EN 203-1:2021, BS EN 203-2-10:2007, BS EN 203-3:2009

I, the undersigned, hereby declare that the equipment specified above conforms to the above Directive(s) and Standard(s).

Date: 10.6.2023

Signature:

A handwritten signature in black ink, appearing to read 'Hakan Baykal', is written over a light blue rectangular background.

Full Name: Hakan Baykal

Position: Purchase Manager